

D-Subminiature Accessories

Ultra High Vacuum D-sub Feedthroughs, Connectors and Accessories

AML produce a range of accessories to complement our UHV compatible products. The D-Subminiature feedthroughs, connectors and accessories support the ease of use and performance of AML stepper motors and stages.

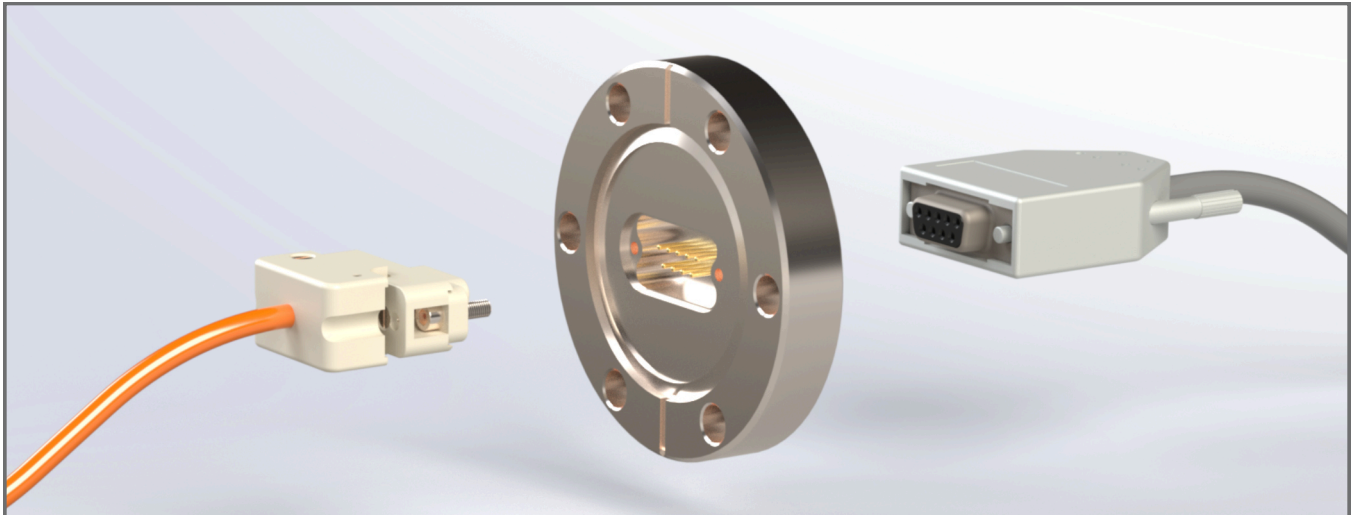

FEEDTHROUGHS



VF9D-40CF

D-sub 9-way feedthrough on a DN40 CF flange (70 mm OD). Individual glass-ceramic compression seals and bakeable to 250°C. Suitable for use to 1.3×10^{-10} mBar (1×10^{-10} Torr). Male to male connection. 1.01mm gold plated pins. Rating. 500V, 5 A per pin (max 20% of pins).



VF15D-63CF

D-sub 15-way feedthrough on a DN63 CF flange (114 mm OD). Individual glass-ceramic compression seals and bakeable to 250°C. Suitable for use to 1.3×10^{-10} mBar (1×10^{-10} Torr). Male to male connection. 1.01mm gold plated pins. Rating. 500V, 5 A per pin (max 20% of pins).

VACUUM-SIDE CONNECTORS



VCxxDF

UHV, bakeable D-sub connector. 9-way and 15-way female connectors available for mating with the VFxxD-xxCF feedthroughs. Suitable for use to 1.3×10^{-10} mBar (1×10^{-10} Torr).

VACUUM-SIDE STRAIN RELIEF



VCxxDB

UHV, bakeable D-sub strain relief for VCxxDF PEEK D-sub connectors. Suitable for use to 1.3×10^{-10} mBar (1×10^{-10} Torr).

AIR-SIDE CONNECTORS



CON-DxxM

Air-side D-sub connectors. 9-way and 15-way male connectors available. Supplied with backshell and crimps.

PINS AND TOOLING



XCRDSUB

Crimp tool for D-sub connectors.

VCDSKT

D-sub female crimp sockets. Bag of 10.

DIMENSIONS

VC9DF

Pin Number Locations

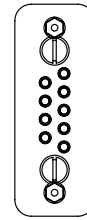
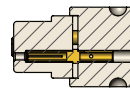
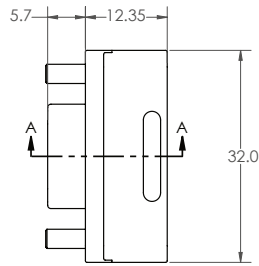
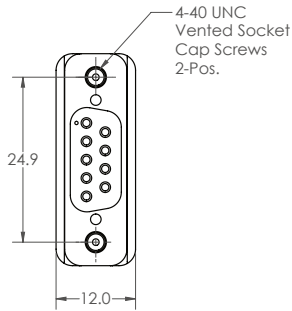
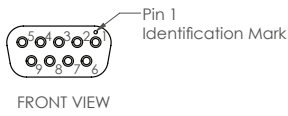

20-24 AWG Machined D-Sub Socket Crimp
P/N 030-1953-000

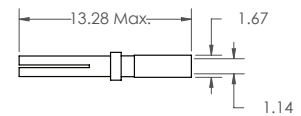

VC15DF

Pin Number Locations

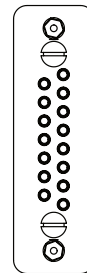
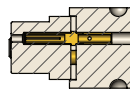
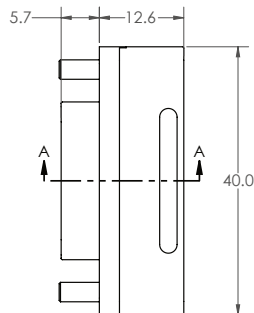
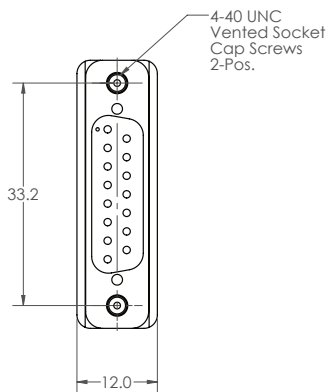
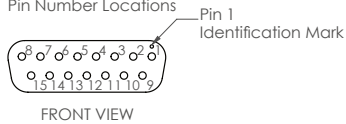

20-24 AWG Machined D-Sub Socket Crimp
P/N 030-1953-000

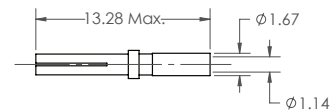

ORDERING INFORMATION

| Order Code | |
|------------|---|
| VF9D-40CF | D-sub 9-way feedthrough |
| VF15D-63CF | D-sub 15-way feedthrough |
| VC9DF | D-sub 9-way PEEK connector |
| VC15DF | D-sub 15-way PEEK connector |
| VC9DB | Strain relief for 9-way PEEK D-sub connector |
| VC15DB | Strain relief for 15-way PEEK D-sub connector |
| CON-D9M | D-sub 9-way, male. Air-side connector |
| CON-D15M | D-sub 15-way, male. Air-side connector |
| XCRDSUB | Crimp Tool for D-sub Connectors |
| VCDSKT | D-Subminiature Pins and Tooling. Bag of 10 |



Arun Microelectronics Ltd.
Unit 2, Bury Mill Farm
Bury Gate
PULBOROUGH
RH20 1NN
United Kingdom

Tel: +44 (0)1903 884141
Email: sales@arunmicro.com

AML pursues a policy of continuous improvement and reserves the right to make detail changes to specifications without consultation. E and OE.